



# AGRICULTURE

**FLAIL MOWERS FOR  
AGRICULTURAL APPLICATIONS**

# INNOVATION MEETS TRADITION

## The basis for sustainable success

Müthing is one of the leading suppliers of innovative mulching technology in Europe. Customers from 32 countries have associated the Müthing brand with quality products "Engineered in Germany" for many decades.

In 1898, the Müthing company was founded as a trader of scythes and spare parts in the Sauerland region. The first Müthing flail mower was developed, designed and sold as far back as 1998. Just two years later, the flail mowers were being exported to many different countries.

A family business with more than 120 years of tradition. Passion and experience, combined with a customer-focused approach, form the heart of the company - which is now being managed by the 4th generation of the family.

Customers, employees and system partners place a great deal of trust in the company due to its qualities of reliability and independence. This helps to ensure the long-term success of the company.

For many years, Müthing has been a byword for outstanding work results thanks to its pioneering Vario flail mowers.



The development and sales centre with assembly halls of Müthing GmbH & Co KG Soest.



Satisfied customers are the goal of our work.



Founded in 1898 as a spare parts and scythe trader by Josef Müthing (framed picture), f.l.t.r.: Romanus Müthing, Dr. Michael Müthing



The assembly hall at the Soest location - Technology in perfection.

In cooperation with technology partners from the scientific and research sectors, as well as customers from many countries, the company is continuously developing new products that combine agriculture and sustainability.

Constant innovations are the key to designing professional and contemporary landscaping technology combined with sustainable protection of insects to preserve the overall ecological environment. Through constant dialogue with users, the family company produces flail mowers that meet the high demands of daily use and fulfill practical requirements.



## CONTENTS

<b>Why mulching?</b>	4-5
<b>Müthing flail mower in detail</b>	6-15
<b>Our product range (brief overview)</b>	16-21
<b>Flail mower model series</b>	22-55
<b>Service</b>	56-57
<b>Technical data</b>	58-59

# WHY YOU SHOULD MULCH



## MULCHING: AN IMPORTANT PART OF MODERN AGRICULTURE

Modern agriculture is about more than just producing food. Your customers/consumers have high expectations of the products as well as the production methods.

- Little or no pesticides
- Environmentally compatible farming methods
- Sustainable farming with consideration for the landscape
- Increased soil fertility

One aspect of efficiently meeting these criteria involves helping nature with its natural processes.

- Finely mulched crop residues promote fast decomposition. This prevents diseases and pests from developing.
- Crop residues which decompose rapidly provide nutrients for the next crop. Uniform distribution of the residues also means uniform distribution of the nutrients.

- A uniform layer of mulch prevents soil erosion, promotes soil warming and supports water conservation.
- Coarse mulching of catch crops effectively stops them from turning to seed, thus preventing unwanted plants in the next main crop.

Coarse mulching of catch crops keeps the nutrients bound longer and prevents leaching.

Fine mulching of field edges prevents seeds from entering the soil and ensures an appealing appearance after just a short period of time.

With Müthing flail mowers, you can achieve the results you need for your particular application. Our Vario-System® allows the flail mower to be specially adapted and to shred efficiently and economically in both intensive and non-intensive applications.

# SUSTAINABLE FARMING SUCCESS



**GRAIN STUBBLE** Uniform shredding and distribution of the crop residues ensures a smooth soil preparation and sowing process. Fast decomposition of crop residues and optimal germination of volunteer grain reduces the use of pesticides in the next main crop. The uniformly distributed crop residues provide an even spread of nutrients and a homogenous main crop.



**MAIZE STUBBLE AND MAIZE STOVER** Stubble which is shredded down to the rootstock provides little protection for leafroller larvae and disintegrates very quickly. Harvesting difficulties which can occur if the stubble is not shredded every year are avoided. Well-shredded maize stalk decomposes quickly and this prevents Fusarium fungi from multiplying. As well as improving the quality of the next crop, this also significantly reduces the risk of high DON content\*.

DON content = Proportion of deoxynivalenol (mycotoxin mould toxin)



**RAPE STUBBLE** Mulching breaks open unripe pods and exposes volunteer oil-seed rape plants. The mulch is discharged in front of the support roller, which ensures even distribution and consolidation of the crop residues and volunteer seeds. This results in excellent germination of the volunteer rape seeds. Diseases and fungi can persist in rape stalks for a long time, while natural decomposition is also a very lengthy process. Intensive shredding speeds up this process and spore-producing fungi are not able to multiply.

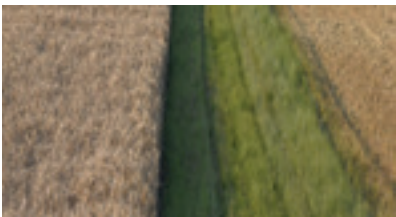

**FIELD EDGES** Field edges which act as a margin between pathways and cropped land have a high ecological value. Alongside a wide variety of insects and wild animals, many wild herbs can also be found here. Mulching shortly before the dispersal of seeds from these weeds and herbs reliably prevents the seed from entering the cropped land. Intensive shredding allows the plants to grow through quickly and the edge of the field regains its rich green appearance.

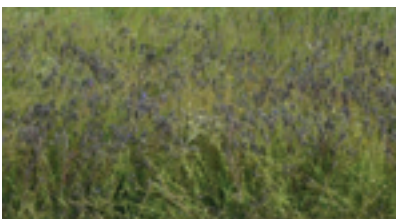

**FALLOW LAND** Fallow land is land which is not being used and where pioneer plants start to grow. Annual care in the form of mulching limits growth, while also ensuring a well-maintained appearance and effectively preventing changes in plant species. The mulch also helps to build up soil humus and increases soil fertility. An efficient result can be achieved with extensive shredding at high speeds.



**GRASSLAND** Grazing cattle avoid plants which are less nutritious and less appealing, as well as the grass around piles of dung. As a result, these grasses can multiply easily and the feed quality of the pasture reduces. Mulching the grazed land reduces the growth of these species and spreads out the luxuriant vegetation. Loose discharge behind the support roller facilitates an aerobic decomposition process without the formation of mold. The result is rapid growth of high quality grasses.

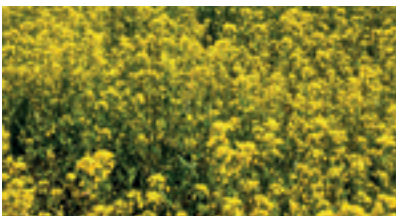

**CATCH CROPS** Catch crops are an option in sustainable agriculture for building up humus and preventing erosion. Nutrients are stored and re-used in the next main crop through decomposition. Appropriate mulching at low intensity in the autumn stops the growth. In spring, intensive shredding speeds up the rotting process so that the soil surface can dry out more quickly and the soil warms up faster. The mulching process is thus the key to success in modern agriculture and is an environmentally friendly alternative following greening regulations.

# MÜTHING FLAIL MOWER IN DETAIL

## WHY MÜTHING FLAIL MOWERS CAN DO MORE

The sum of all details come together to make a Müthing flail mower perfect for use on your land.



**1.** The **highly tempered spring steel flaps** with swing protection provide safety for you, your fellow workers and your tractor. They hold back foreign objects reliably and reduce damage.



**2.** **Two rows of highly tempered spring steel flaps with swing protection** provide additional protection at very high implement speeds. You will find this increased safety in all MU-Farmer® models.



**3.** The **Technical Inspection Association (TÜV-Nord) stone projection test** is your assurance that we have done everything possible to ensure the safety of you and other people within the operating area of the flail mower. The safety distances are thus reduced to 2m alongside the machine and 8m in front of and behind the machine.



**4.** **Fine-grain steel** is the material that is used to make Müthing flail mowers. Its outstanding wear-related properties and high strength allow our machines to be lighter. This reduces the weight on the tractor and on the ground.



**5.** The **shark fin** has a self-cleaning and replaceable design. It ensures uniform shredding of all of the material. Long material is fed through the rotor in a second step in the crop flow, whereas material that is already shredded passes through. The result is homogeneous mulched material.



**6.** The **mechanical side shift** allows the flail mower to be adjusted to the tractor track or offset to the side. The adjustment can be made manually for a constant working position without any further requirements on the tractor.

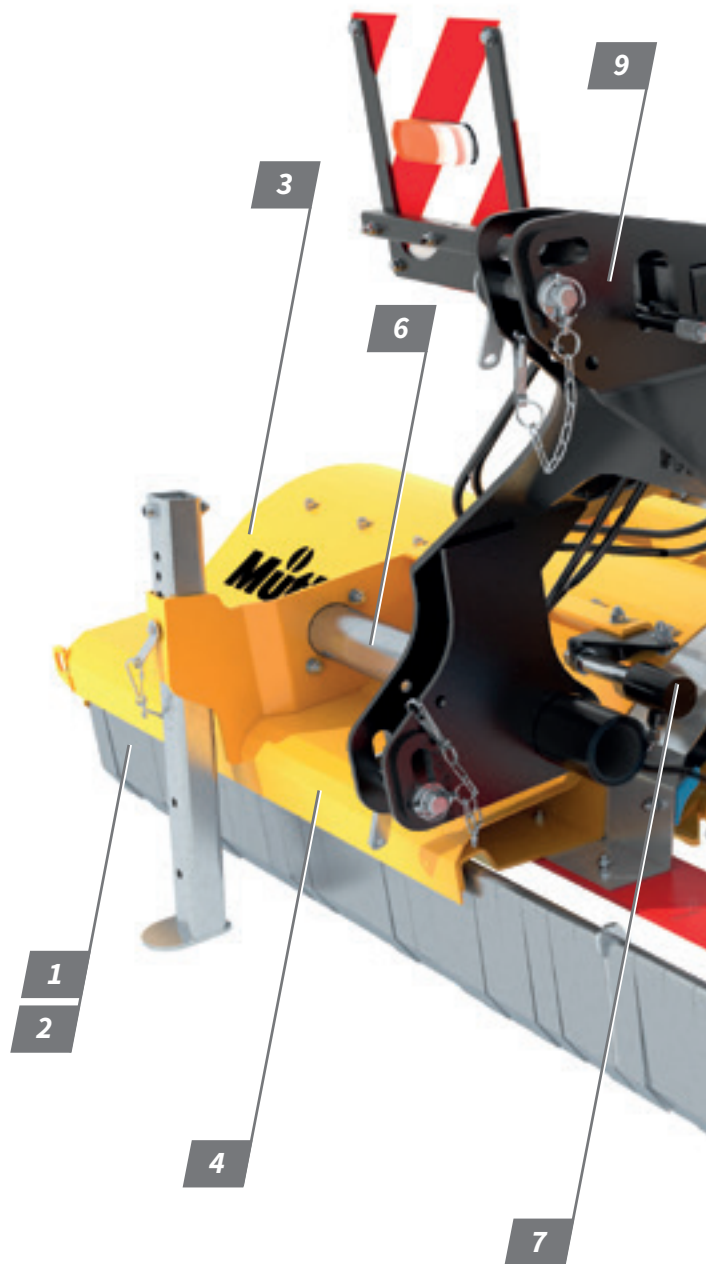

**7.** **Hydraulic side shift\*** makes it possible to work around posts and trees or operate the flail mower outside of the tractor track. On the edges of tracks or embankments, the tractor remains on a solid surface while the flail mower can operate alongside it.



**8.** **Freewheel in the gear box/hydraulic motor** prevents damage to the PTO clutch due to abrupt braking when the torque is too high. Incorrect operation of the drive system is no longer possible.

# KEY FEATURES THAT MAKE A BIG DIFFERENCE

Example shows the MU-M 280 Vario:

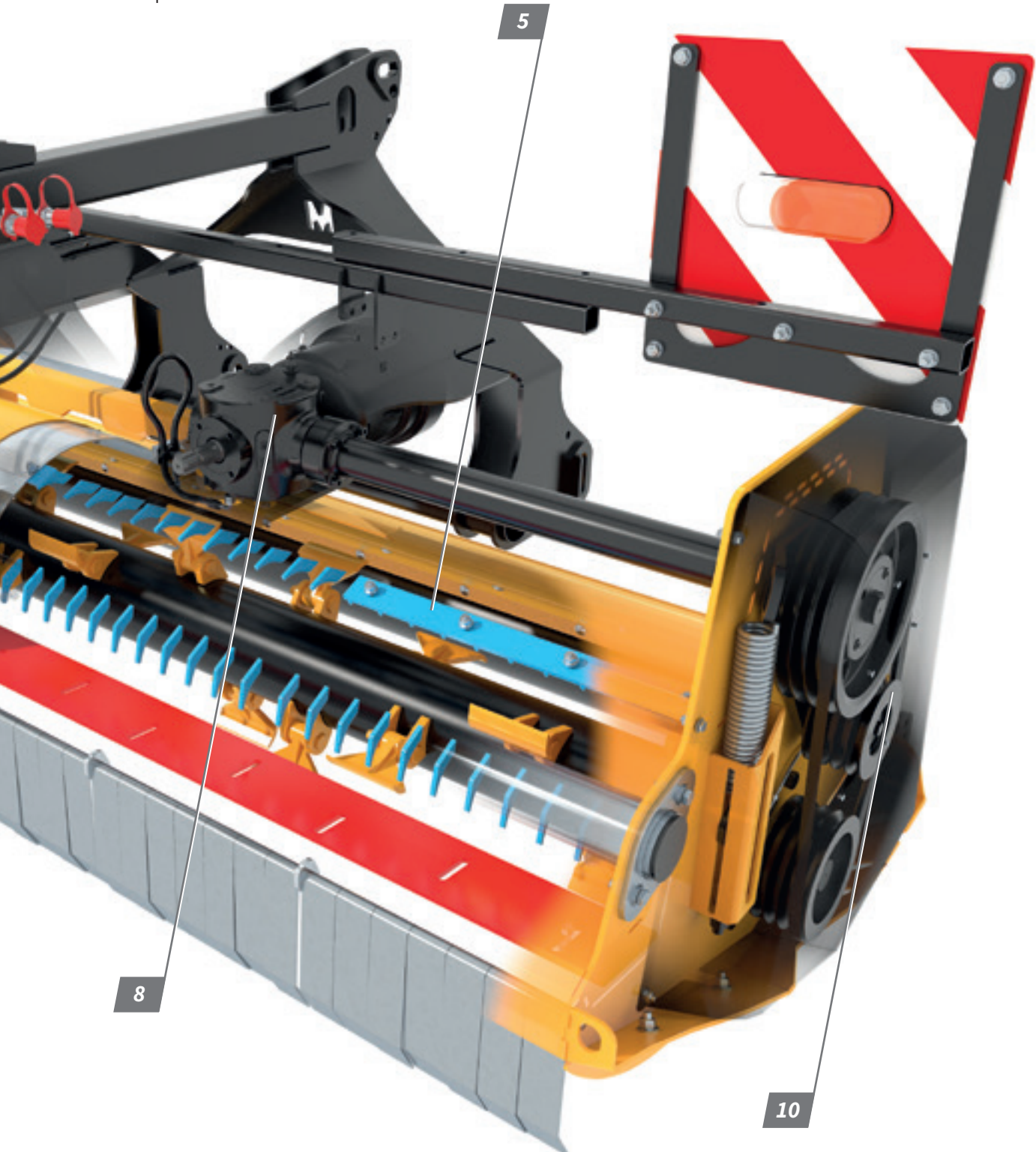

**9.** The **Front-Rear headstock\*** allows mounting in front of or behind the tractor, without any additional installation complexity. Decide whether you want to mount at the front or at the rear depending on the task and tractor.



**10.** **Automatic belt tensioning** keeps the V-belt under tension, whether it is cold or warm and whether the belt is new or already run in. Once adjusted, the tension is automatically maintained at the set level.

(\*Optional in some cases)

# MÜTHING FLAIL MOWER IN DETAIL

Example shows the MU-M 280 Vario:

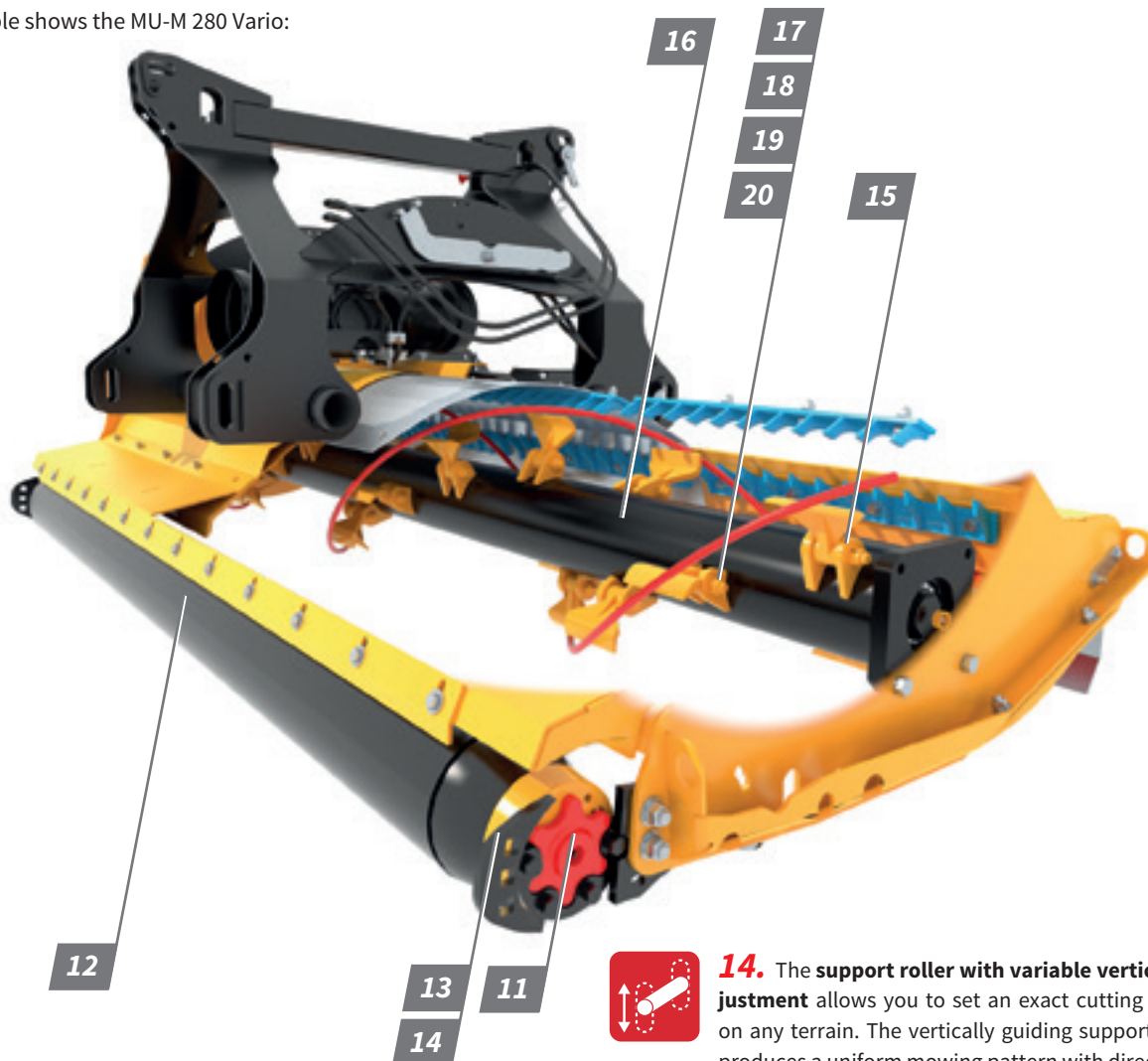

**11.** The **Starinth® support roller bearing** is Müthing's heavy duty support roller bearing. With lifetime lubrication, the bearing is protected by a labyrinth seal and housed in a unit which is mounted in a star-shaped contour to prevent twisting. Impacts on the bearing are minimised by the star shaped contour and the service life of the bearing is thus optimised.



**12.** The **adjustable support roller\*** turns the flail mower into a machine that can be used all year round. When performing pasture care or edging work, the front roller position discharges the material loosely behind the roller to ensure fast decomposition. The rear position of the support roller ensures prompt germination of the volunteer seeds in rape crops.



**13.** The **vertically adjustable support roller/support wheels\*** make it possible to adjust the mower to different working heights. Crop remnants that are mulched to a minimum can be achieved just as easily as lush green sward.



**14.** The **support roller with variable vertical adjustment** allows you to set an exact cutting height on any terrain. The vertically guiding support roller produces a uniform mowing pattern with directional mowing stripes and the best possible mulch distribution.



**15.** The **tangential tool holders** lift the rotor over obstacles and thus protect against imbalance. The connection to the rotor is improved by the longer weld seam, which prevents the tool holders from breaking off.



**16.** The **twin-spiral rotor** ensures uniform operation of the rotor. This reduces fuel consumption, while also reducing the load on the drive line at the same time. This extends the service life of the gear box and PTO shafts. The internal bearing and wide bearing shells provide protection against foreign objects and perform an anti wrapping function.



**17.** The **M-DuraX hammer flail** used by Müthing flail mowers. It is characterised by high resistance to wear and powerful performance. Whether you are looking to make a clean cut through grass or shred some shrubbery, the high quality M-DuraX M-hammer flail gives you plenty of options.



# KEY FEATURES THAT MAKE A BIG DIFFERENCE

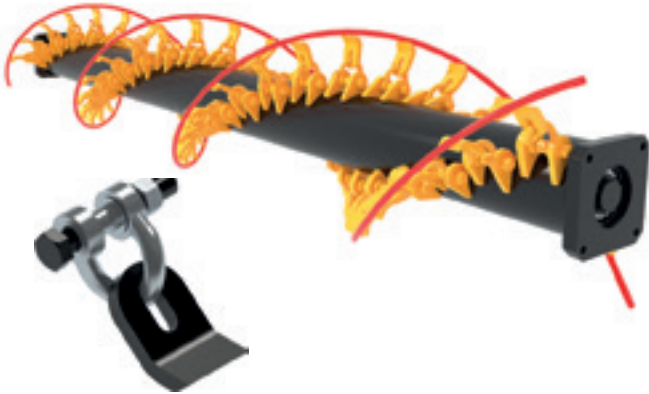

**18.** The **M-shackle flail rotor\*** is used where frequent contact with foreign objects is to be expected. The shackles give the flails the required clearance to avoid foreign bodies. This protects against damage and allows trouble-free operation.



The **M-DuraX hammer flail** with high strength boron alloyed and tempered steel ensures high wear resistance with a new optimised alloy. This enables up to 50% longer use. The optimal ergonomic properties produce a perfect mulching result. The M-DuraX hammer flail is smoother running for better self-sharpening and lower diesel consumption.

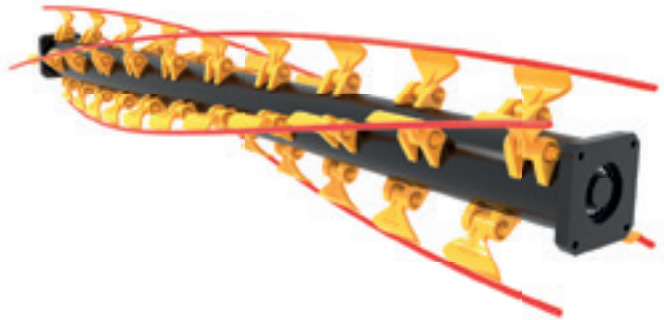

**19.** The **2Cut double cutting rotor with M-DuraX hammer flail \*** enables more efficient working due to a special arrangement of the mulching tools: with 75% more tools, the cutting rate is increased by 100%. The tool arrangement operates at double the cutting rate of conventional rotors and thus enables an increased working speed combined with reduced rpm. \* Available for MU-PRO Vario, MU-PRO/S Vario, MU-PRO/F Vario and MU-M/F 600 Vario.



**20.** **Triple Y-blades\*** use less power and are interchangeable with the M-hammer flails. They generate less air movement, which reduces dust impact.

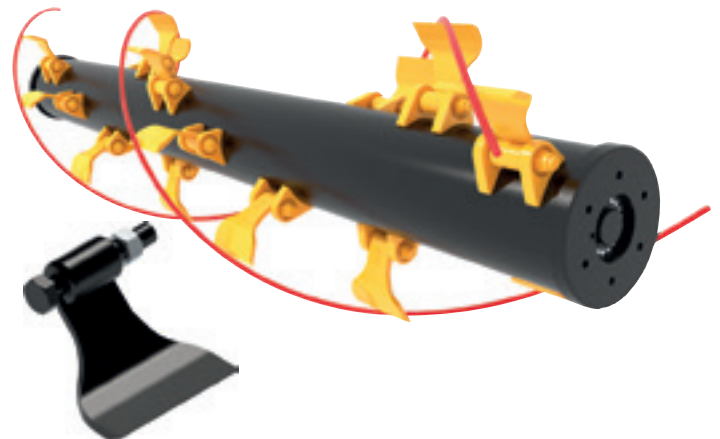

**21.** **MU-Farmer® hammer flails** are an indestructible tool in your flail mower. Made out of rolled steel and weighing 2.7 kg, they provide extreme durability even under high throughput rates or with light ground contact.

(\*Optional in some cases)

# MÜTHING FLAIL MOWER IN DETAIL

## THE MU-VARIO® SYSTEM FROM MÜTHING

### For maximum working convenience and flexibility



**22.** The **MU-Vario® System** allows you to adjust the flail mower to your conditions thanks to its optimal intake and housing form, variable PTO shaft speeds, an infinitely variable Vario cutting bar and the swivelling support roller.

**1.** The **adjustable cutting bar** allows infinitely variable adjustment of the shredding rate to the respective requirement.

- Optimal mulching result even in wet conditions, on tramlines, with low plant mass content or plant mass that is difficult to shred.
- Compacted crop residues can be reached due to the strong suction effect
- The shredding can be individually optimized to each crop, irrespective of whether you are mulching maize stubble or catch crops.

Higher vehicle speeds and higher surface outputs with constant quality are possible thanks to the infinitely variable shredding rate.

#### **2. Shark fin:**

- Uniform shredding of all particles and homogeneous mulch
- Long material is fed to the rotor in a second step, where as material that is already shredded passes through.
- Self cleaning and replaceable
- No clogging of the flail mower housing with soil or grass

**3.** The **swivelling support roller** turns the flail mower into a machine that can be used all year round. The mulch can be deposited either in front of or behind the support roller (available as of the MU-M series).

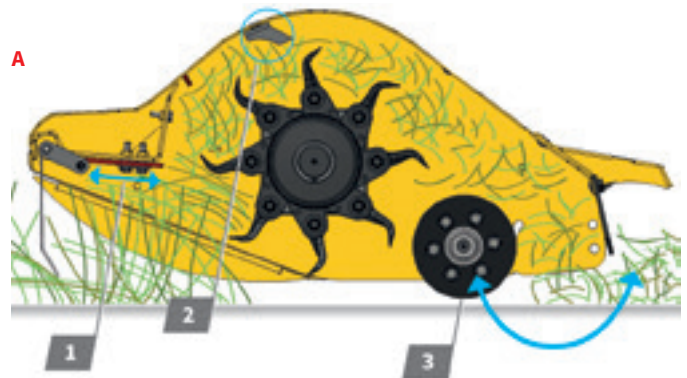

#### **A Support roller swivelled to front:**

- Loose depositing of mulch behind the support roller
- Ideal for the care of pastures and verges
- Optimal shredding of catch crops with loose deposition
- Fast decomposition of the mulch
- Exact depth control

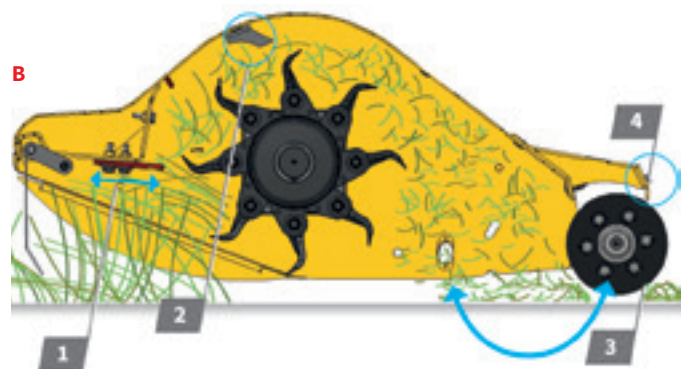

#### **B Support roller swivelled to rear:**

- Depositing of mulch in front of support roller
- Pressing of mulch by support roller
- Optimal seed to soil contact ensures prompt germination of volunteer seeds
- Lower dust impact with front attachment
- Trouble-free soil cultivation

**4.** The sturdy support roller scraper rail (optional) ensures trouble free mulching work even in extremely wet conditions.

# KEY FEATURES THAT MAKE A BIG DIFFERENCE



## Versatile use - The correct processing for every crop

Individual settings tailored to different crops for mulching after rape, grain stubble, maize, catch crops and for grassland care.



## Flexible shredding rate adjustment

The shredding rate of the mulch can be variably adjusted thanks to the adjustable cutting bar.



OUR VIDEO TIP: **VARIO MULCHING**

**The solution for successful crop production**  
See how mulching improves crop production on YouTube. Just scan the QR code!

Low degree of shredding



High degree of shredding

# MÜTHING FLAIL MOWER IN DETAIL



**23.** The **mechanical collision protection device (side arm)** prevents damage in the event of a collision without compromise. You do not have to make any more adjustments, the collision protection device is adapted to the flail mower. You cannot accidentally adjust it incorrectly or forget to use it, the collision protection device is always in operation. A Müthing patent.

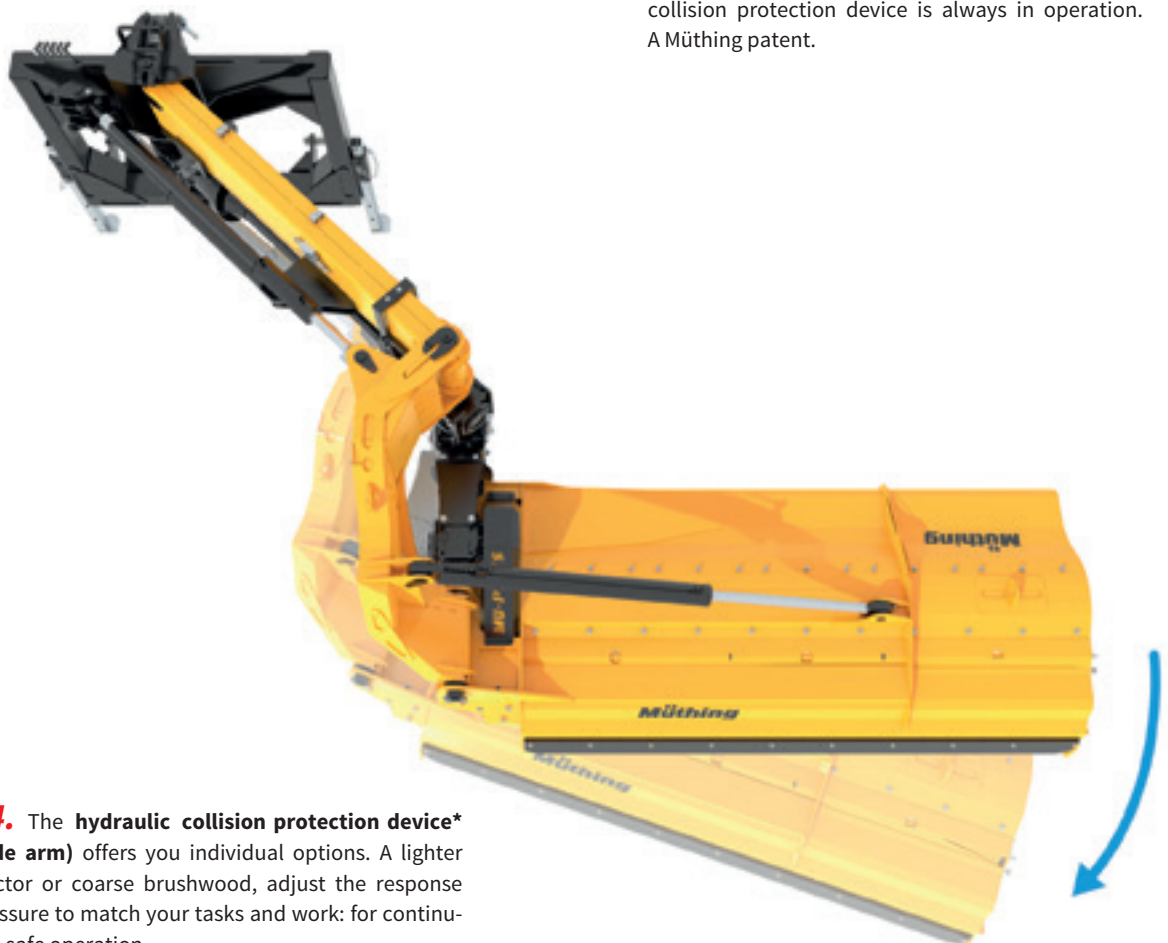

**24.** The **hydraulic collision protection device\* (side arm)** offers you individual options. A lighter tractor or coarse brushwood, adjust the response pressure to match your tasks and work: for continuous safe operation.

(\*Optional in some cases)

# CONVERSATIONS FROM THE FIELD - WHERE THE EXPERTS ARE FOUND

## Enthusiastic testimonials from our customers

The satisfaction of our Müthing customers is close to our hearts. Here you can read more about their successes in using our flail mowers.

**"In my eyes, the flail mower is an important component in the overall system"**

**Farm Manager Maximilian von Laer**

At Gut Fürstenberg (North Rhine-Westphalia), we have been using a combination of front flail mower and rear side flail mower for field edge and track edge maintenance for several years. For stubble processing, we use a rear flail mower with a working width of 6 metres. In this way, we effectively prevent infestation by corn borer. It also significantly reduces the risk of Fusarium fungi in the next crop.

In rape stubble, we were able to effectively manage the problem of old rape crops by mulching. With regard to the germination of (old) volunteer rape, the flail mower has decisive advantages over mechanical soil preparation in the first pass: It draws in the grains and crop residues, cuts open pods that were still closed and deposits a flat, loose mulch layer behind itself. These are optimal germination conditions!



**"There is no way around mulching."**

**Sebastian Bauer, grassland farmer, Rhön region**

Here in the Rhön region, we have been using mulching technology for 17 years. We currently work with an MU-M 600 for land and pasture care. The variable cutting bar is ideal for this, as it achieves an increased suction effect and better shredding. The grass stands have improved enormously and are much firmer underfoot.

Mulching creates optimal conditions for reseedling. We experience significantly better rotting of the material. This promotes humus formation and supports plant health in the long term.

It is a fact that pastures that are mulched up to 3 times a year can also be grazed up to 3 times, despite the summer drought.

# THROWN-OBJECT TEST CERTIFIED BY TECHNICAL INSPECTION ASSOCIATION



## STAY ONE STEP AHEAD WITH CERTIFIED SAFETY!

- Europe's agricultural machinery manufacturers have to produce their machines in accordance with CE machinery directives.
- Applying the CE marking is a self-declaration of compliance with the CE directives.
- One of these CE machinery directives is entitled: "Thrown-object test and acceptance criteria for flail mowers as per ISO/WD 17101-2".
- We went one step further and commissioned an independent, accredited institute - TÜV Nord - to assess and certify our compliance with this machinery directive.

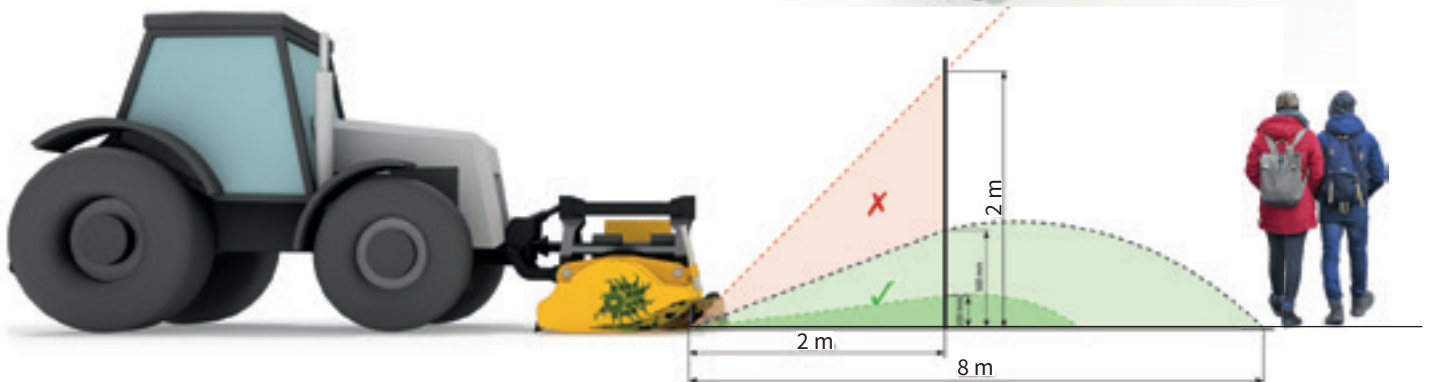

## YOUR ADVANTAGE: MAXIMUM SAFETY AND WORRY-FREE OPERATION

With observation of the safety clearances of 8 metres towards the front and rear and 2 metres towards the right and left.



# MU-SOFA® WEIGHT TRANSFER SYSTEM AS ACCESSORY

## THE ADJUSTABLE HYDROPNEUMATIC MU-SOFA® WEIGHT TRANSFER SYSTEM FOR ALL FRONT-MOUNTED IMPLEMENTS:

- Noticeably improves the steerability and traction of the tractor with front-mounted implements.
- Offers significantly improved comfort for the driver during transport and while working.
- Improves the depth guidance and ground following of front mounted implements and thus the operation of the equipment.
- Makes it easier to maintain a uniform distance from the ground and prevents damage due to heavy contact with the ground.
- Features simple adjustment of the load relief function to various weight and working requirements.
- Protects the implements from wear and absorbs vibrations during transport and while working.
- Removes the need for additional implement accessories such as front wheels and shock-absorbing spring assemblies.

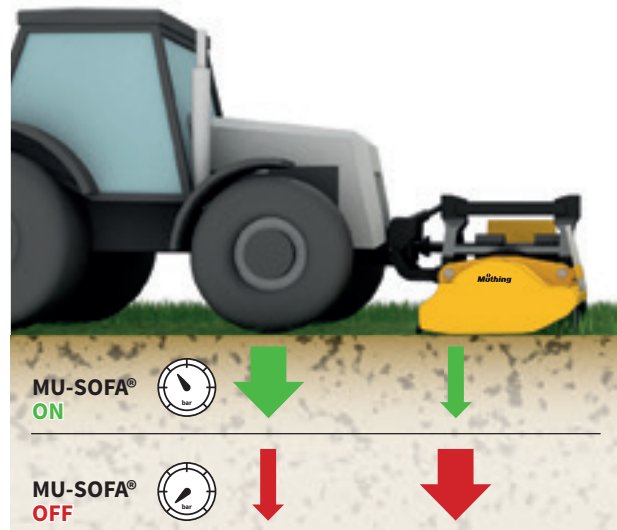

### MU-SOFA® tractor mounting

Mounted directly on the tractor, the contact pressure can be quickly adjusted when switching between front-mounted implements such as flail mowers, mowers or snowploughs. The MU-SOFA® can be easily integrated into all of the hydraulic circuits commonly used in front hydraulic systems (installation time approx. 4 hours).



### MU-SOFA® implement mounting

With MU-SOFA® mobile, permanent attachment to the respective implement is possible. To do so, an additional T-piece is connected to the hydraulic feed line of the tractor.

# OUR PRODUCT RANGE

## MU STANDS FOR MULCHING WITH MÜTHING

The widest range of flail mowers for agricultural use. Designed to take care of your specific shredding task. A top-class mulching result is something that all Müthing flail mowers have in common. You can depend on it!



Page 22-23

### **MU-CONNECT 200**

Front mounting

- Wheel loader mount for flail mowers of the MU-E Hydro Vario series
- For vehicles with up to 90 l/min hydraulic output



Page 24-25

### **MU-ECOTOP**

Rear mounting

- Classic entry-level machine for smaller scale areas
- Basic mulching around the house and farm
- Müthing quality at an entry-level price
- Suitable for driving powers from 30 to 75 hp\*
- Working width: 1.60 m/ 1.80 m/ 2.00 m



Page 26-27

### **MU-H Vario**

Front or rear mounting

- Entry-level machine with professional equipment and adjustment options
- Light mulching for agricultural applications
- Hydraulic side shift and MU-Vario® System
- Suitable for driving powers from 35 to 75/90 hp\*
- Working width: 1.20 m/ 1.40 m/ 1.50 m/ 1.60 m/ 1.80 m/ 2.00 m/ 2.20 m



# THE SHREDDING EXPERTS, A MATCH FOR ANY CHALLENGE



Page 28-29

## **MU-H/S Vario**

Rear attachment

- Entry-level rear/side flail mower for mounting on small/lightweight tractors
- Specially suited to maintain field edges
- Versatility thanks to wide side shift. Patented collision protection device
- Suitable for driving powers from 55 to 90 hp
- Working width: 1.40 m/ 1.60 m/ 1.80 m/ 2.00 m

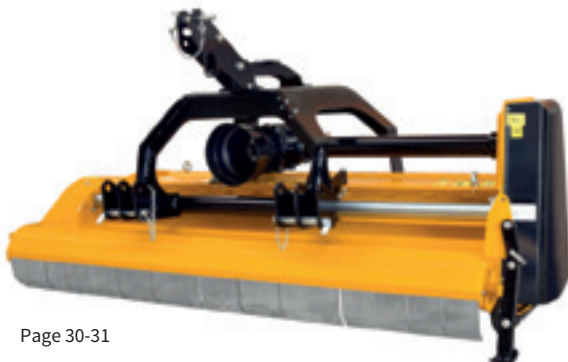

Page 30-31

## **MU-L Vario**

Front and/or rear attachment

- Universal flail mower with large working width
- Front mounting possible even on small/lightweight tractors
- MU-Vario® System with unscrewable support roller (optional)
- Support roller with robust Starinth® support roller bearing
- Suitable for driving powers from 45 to 100/130 hp\*
- Working width: 1.80 m/ 2.00 m/ 2.20 m/ 2.50 m/ 2.80 m



Page 32-33

## **MU-L/S Vario**

Rear mounting

- Versatile rear/side flail mower for large area output
- Large working width as side flail mower, including for medium-sized tractors
- Very large side shift and patented collision protection device
- Support roller with robust Starinth® support roller bearing
- Suitable for driving powers from 75 to 130 hp
- Working width: 2.00 m/ 2.20 m/ 2.50 m

\* Some illustrations show optional equipment. The right to technical revision is reserved. Illustrations may not show the latest production version. Some model series can be converted from 540 rpm to 1000 rpm, which makes higher driving powers permissible. In these cases you will see two horsepower values.

# OUR PRODUCT RANGE



Page 34-35

## **MU-M Vario**

Front and rear mounting

- The standard flail mower for the farmer
- Versatile adjustment options. Large opening thanks to swivelling support roller. Sturdy drive line for front and rear mounting with automatic V-belt tension. Support roller with robust Starinth® support roller bearing
- Variable adjustment of shredding rate
- Suitable for driving powers from 75 to 160 hp
- Working width: 2.20 m / 2.50 m / 2.80 m / 3.00 m



Page 36-37

## **MU-Vario-Shark 2.0**

Front and rear attachment

- Arable farming special edition in special colour for front and rear mounting with additional equipment
- Suitable for all areas of arable farming
- Headstock designed for large tractor series
- Optimised clearance between support roller and rotor to ensure that even long stalks are processed in their entirety
- Support roller with robust Starinth® support roller bearing
- Suitable for driving powers from 95 to 200 HP
- Working width: 2.80 m / 3.00 m



Page 38-39

## **MU-M/F Vario**

Rear mounting

- Centrally folding flail mower for greater work rate and high surface output
- Simple operation and fast turning without lifting due to support wheels that rotate through 360°
- Hydraulically driven central strip flail mower
- Support roller with robust Starinth® support roller bearing
- Suitable for driving powers from 130 to 300 hp
- Working width: 6.00 m



Page 40-41

## **MU-M/S**

Rear mounting

- Side/embankment flail mower also suitable for area use
- Inclination-adjustable mulching housing allows flexible adjustment to embankments and ditches
- Adjustable hydraulic collision protection device for maximum safety
- Suitable for driving powers from 95 to 160 hp
- Working width: 1.80 m / 2.00 m / 2.20 m / 2.50 m

# THE SHREDDING EXPERTS, A MATCH FOR ANY CHALLENGE

**NEW**



Page 42-43

## **MU-M/S Vario PLUS**

Rear attachment

- The expert's choice for working on embankments
- Very large side shift
- Compact transport dimensions with low centre of gravity
- Integrated weight transfer system on flat surface
- Support roller with robust Starinth® support roller bearing
- Suitable for driving powers from 160 to 200 HP
- Working width: 2.20 m / 2.50 m / 2.80 m



Page 44-45

## **MU-PRO Vario**

Front and rear mounting

- Suitable for continuous heavy-duty usage, high driving power and large quantities of crop residues
- Adjustable crop flow flap for optimal discharge of the shredded mulch behind or in front of the support roller
- Variable adjustment of shredding rate
- Support roller with robust Starinth® support roller bearing
- Suitable for driving powers from 95 to 250 hp
- Working width: 2.50 m / 2.80 m / 3.00 m / 3.20 m

**NEW**



Page 46-47

## **CoverSeeder**

Rear attachment

- Sowing of catch crops without soil preparation in a single operation
- Improved distribution of crop residues
- Perfect seed to soil contact thanks to prism roller
- Well-developed catch crops throughout the field
- Suitable for driving powers from 130-250 HP
- Working width: 2.80 m

\* Some illustrations show optional equipment. The right to technical revision is reserved. Illustrations may not show the latest production version. Some model series can be converted from 540 rpm to 1000 rpm, which makes higher driving powers permissible. In these cases you will see two horsepower values.

# OUR PRODUCT RANGE



Page 48-49

## **MU-PRO/F Vario**

Rear mounting

- Foldable large area flail mower
- Each unit features the functional advantages of the MU-PRO
- Manufactured out of extremely durable S700 fine-grain steel
- Operational weight and dimensions comply with German vehicle licensing regulations (StvZO)
- Suitable for driving powers from 200 to 400 HP
- Working width: 8.60 m

## **MU-PRO/F Trail Vario**

Rear attachment

- Towed large-area flail mower
- Ideal for tractor vehicles without front PTO shaft
- Chassis with excellent ride comfort and hydraulically adjustable work and transport position
- Folds in and out quickly to achieve a transport width of less than 3 m
- Suitable for driving powers from 200 to 500 HP
- Working width: 8.60 m

## **MU-PRO/S Vario**

Rear mounting

- Rear/side flail mower with robust design for professional usage
- Newly designed, straight drive line with swing drives
- Largest side shift range on the market in this power category
- Support roller with robust Starinth® support roller bearing
- Suitable for driving powers from 180 to 220 hp
- Working width: 2.50 m

## **MU-Farmer® 670**

Rear mounting

- Flail mower suitable for large-area coverage, worldwide
- Lengthways transport device, convenient and simple to use
- High cutting rate. Unique MU-Farmer® rolled steel hammer flail with 3-year warranty against breakage
- Suitable for driving powers from 240 to 300 hp
- Working width: 6.70 m



Page 50-51



Page 52-53



Page 54-55

# EXPERIENCE MÜTHING FLAIL MOWERS LIVE - PUT US TO THE TEST



## NEED TO SEE IT FOR YOURSELF? NO PROBLEM!

Agriculture, landscaping or special crops - operating reliability and the best mulching result regardless of where and how you want to work. It will be our pleasure! Every Müthing flail mower is a specialist when it comes to first class mulching quality and shredding. You can rely on our flail mowers because ultimately we build machines for you and your needs.



# MU-CONNECT 200

## WHEEL LOADER MOUNT FOR FLAIL MOWERS OF THE MU-E HYDRO VARIO SERIES

- For mounting on small to medium sized yard and wheel loaders up to 90 l/min
- Play-free and quick coupling thanks to the custom fit vehicle specific mounting parts
- MU-CONNECT 200 ensures both exact cutting height guidance and the required clearance for any terrain
- Scuffing during steering manoeuvres is prevented by the low weight loading of the support roller and the ground is thus protected



Hydraulic motor l/min:



Working width in metres:



# ECONOMY AND EFFICIENCY ON WHEEL LOADERS

Adapter plates (examples) for



Adapter plates are also available for the following models: Ladog, Multicar Tremo, Multicar Fumo, Hansa, Holder Muvo and Manitou wheel loader.



Vehicle-specific mounting parts: The low coupling point ensures a good overview thanks to the low linkage position. Good accessibility to the hydraulic connections.



Virtual pulling point - A Müthing patent: The flail mower is pulled with low rolling resistance instead of pushed and thus follows every ground contour perfectly.



Clever contour following when cornering as the machine follows the steering radius.



The correct work position can be determined conveniently using a height indicator visible from the cab.

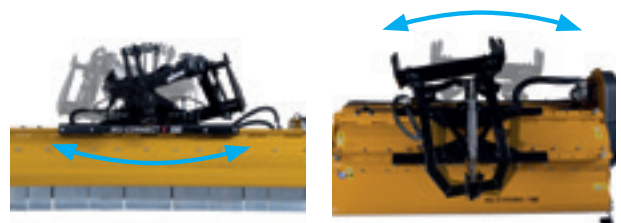

On uneven surfaces, generous swinging and steering movements ensure optimal ground following.

## Technical Specifications

MU-E Hydro Vario	140	160	180	200
Working width (cm)	140	160	180	200
Total width (cm)	155	175	195	215
Weight (kg)	280	330	360	380
Number of carbide M-shackle flails	24	28	32	36
Oil volume, l/min	0-90	50-90	50-90	50-90

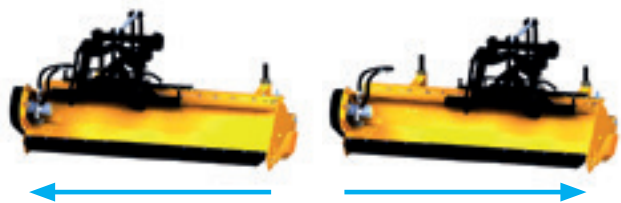

Hydraulic side shift with 26 cm adjustment travel. Mulching at an offset to the side of the tractor provides flexibility for trees, access zones or other obstacles (optional). Mechanical side shift is equipped as standard.

# MU-ECOTOP

## IT'S ALL ABOUT THE BASICS

- From pasture care to mulching work around the farm - everything is possible
- Müthing mulching quality with the equipment you need
- Simple handling: Both mounting and working



Driving power in hp:



Working width in metres:

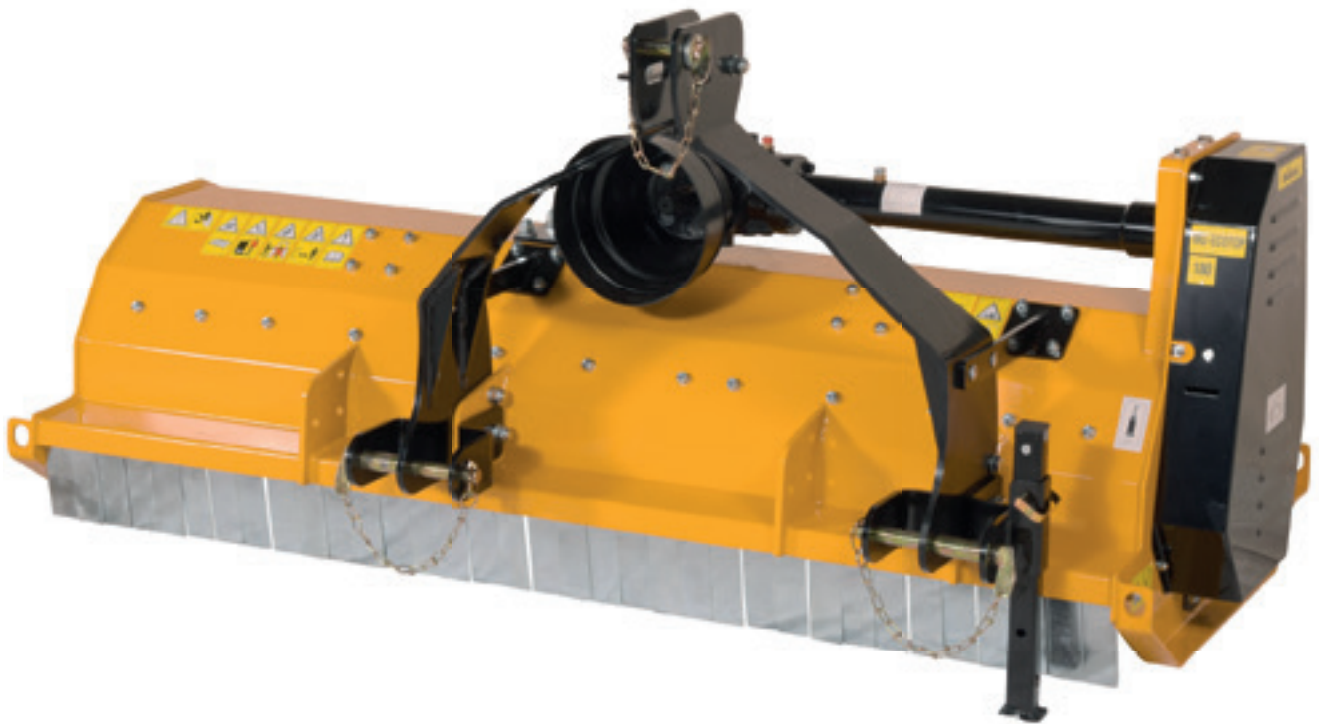



# THE STARTING POINT FOR BETTER MULCHING



The headstock of the MU-ECOTOP can be unbolted and moved behind the tractor and offset to the side.



Typically Mühling - High-quality components even in the entry level category.

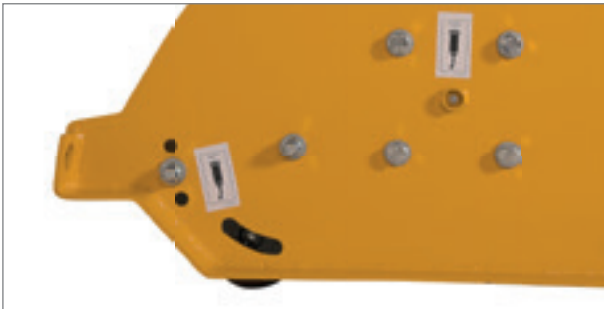

Adjustable support roller for depth control.



Direct power transmission with pre-tensioned belts of premium quality.

## Technical Specifications

MU-ECOTOP	160	180	200
Working width (cm)	160	180	200
Total width (cm)	177	197	217
Max. tractor HP at 540 rpm	60/75	60/75	60/75
Weight (kg)	352	372	390
Number of M-DuraX hammer flails	14	16	16

# MU-H Vario

## ENTRY LEVEL FLAIL MOWER WITH PLENTY OF OPTIONS

- Lighter flail mower for any terrain. Even small tractors can be used, especially in Alpine settings
- MU-Vario® system available
- Use the MU-H Vario as it suits you, with front or rear mounting on your tractor (optional)
- Customised working width for your application
- Gear box with double freewheel, for changed power take-off rotation direction (optional)



Driving power in hp:

35 90

0 hp

500 hp

Working width in metres:

1.2 | 1.4 | 1.5 | 1.6 | 1.8 | 2.0 | 2.2

1.0 m

10.0 m



# A MULTI-TALENTED ENTRY-LEVEL FLAIL MOWER



Use with front or rear mounting possible (optional).



MU-Vario® for an optimised intake and housing form and steplessly adjustable shredding rates. The result is ideal mulch quality and shredding performance.



Hydraulic side shift: Mulching at an offset to the side of the tractor provides flexibility for trees, access zones or other obstacles (optional).



PTO shaft speeds of 540 or 1000 rpm are possible.

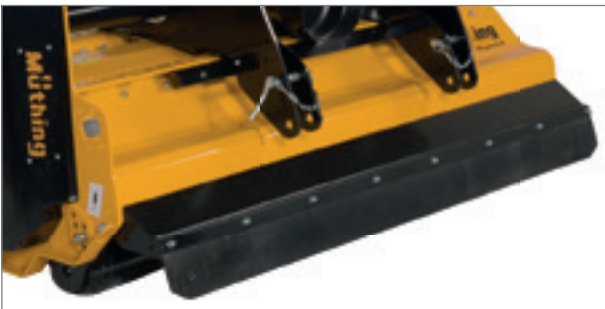

The dust protection system for carrier vehicles prevents obstruction of the field of view and excessive soiling of low-lying intake points due to the production of dust (optional).



Insect rescuer: A specially designed, hydraulically folding bracket with integrated angled tines frightens away insects and small organisms from the front of the flail mower and causes them to flee. (optional for working widths of 1,60 m and 2.20 m)

## Technical Specifications

MU-H Vario	120	140	150	160	180	200	220
Working width (cm)	120	140	150	160	180	200	220
Total width (cm)	137	157	167	177	197	217	237
Max. tractor hp 540/1000 rpm	75/90	75/90	75/90	75/90	75/90	75/90	75/90
Weight (kg)	380	465	480	500	535	555	615
Number of M-DuraX hammer flails	10	12	12	14	16	16	18

# MU-H/S Vario

## ENTRY LEVEL REAR/SIDE FLAIL MOWER FOR SMALLER AGRICULTURAL TRACTORS

- The compact design of this unit simplifies mulching between obstacles such as trees
- MU-Vario® system available
- With a housing height of just 44 cm, it is easy to mulch the area underneath fences
- Whether you are working in ditches or on embankments, the MU-H/S Vario allows you to follow every contour
- Just two double acting services allow you to control the machine
- Mulch both behind and alongside the tractor
- Hardox wear runners, Shark fin shredding bar-standard



Driving power in hp:



Working width in metres:



# FIRST STEP INTO FIELD HYGIENE



The patented mechanical collision protection device responds reliably and returns automatically to the working position.



MU-Vario® for an optimised intake and housing form and steplessly adjustable shredding rates. The result is ideal mulch quality and shredding performance.



A large swivel range makes it possible to work both behind and alongside the tractor. Narrow access tracks and field edges can be mulched just as easily.



Plenty of space for mounting on the tractor and the swivelling PTO shaft.



Rotating warning signs with LED lighting equipment and lighting equipment support with sturdy mounting and without moving components (optional).

## Technical Specifications

MU-H/S Vario	140	160	180	200
Working width (cm)	140	160	180	200
Max. tractor hp	90	90	90	90
Weight (kg)	650	660	690	720
Number of M-DuraX hammer flails	12	14	16	16
Minimum tractor weight (kg)	1.800	2.000	2.200	2.400

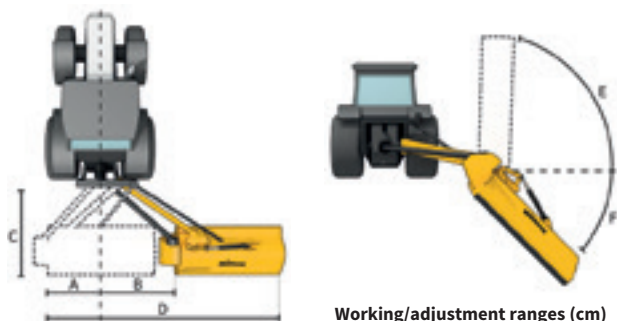

	140	160	180	200
A	55	55	55	55
B	100	100	100	100
C	185	185	185	185
D	295	315	335	355
E	90	90	90	90
F	60	60	60	60

### Working/adjustment ranges (cm)

**A** Adjustment range to left approx.  
**B** Adjustment range to right approx.  
**C** Transport length to rear approx.  
**D** Total working range incl. equipment width approx.

### Working ranges (°)

**E** Angular range upwards  
**F** Angular range downwards

# MU-L Vario

## UNIVERSAL FLAIL MOWER FOR THE SMALL TO MEDIUM SIZED OPERATION

- Fully equipped for arable and grassland farming
- MU-Vario® system available
- Use the MU-L Vario as it suits you, with front or rear mounting on your tractor (optional)
- Customised working width for your application
- Crop discharge in front of the large support roller is also possible optionally
- Long service life thanks to the internal Starinth® support roller bearing
- Hardox wear runners with separating effect, screw-type - standard



Driving power in hp:



Working width in metres:



# HIGHLY VERSATILE



Use with front or rear mounting possible (optional).



MU-Vario® for an optimised intake and housing form and steplessly adjustable shredding rates. The result is ideal mulch quality and shredding performance.



Hydraulic side shift: Mulching at an offset to the side of the tractor provides flexibility for trees, access zones or other obstacles (optional).



With two sturdy adapter plates, crop discharge in front of the support roller is also possible (optional).



Starinth® rear roller bearing.



Power take-off shaft speeds of 540 or 1000 rpm are possible on the MU-L Vario 180-250.

## Technical Specifications

MU-L Vario	180	200	220	250	280
Working width (cm)	180	200	220	250	280
Total width (cm)	197	217	237	267	297
Max. tractor hp 540/1000 rpm	100/130	100/130	100/130	100/130	--/130
Weight (kg)	640	670	740	790	885
Number of M-DuraX hammer flails	16	16	18	22	24

# MU-L/S Vario

## STRONG PERFORMANCE AT THE EDGE OR IN THE MIDDLE OF THE FIELD

- Full flexibility with a large working width
- MU-Vario® system available
- Whether you are working in ditches or on embankments, the MU-L/S Vario allows you to follow every contour
- Just two double acting services allow you to control the machine
- Long service life thanks to the internal Starinth® rear roller bearing system
- Sturdy rear/side arm
- Mulch both behind and alongside the tractor



Driving power in hp:



Working width in metres:

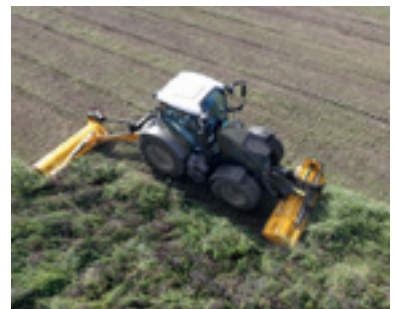



# EXTRA SURFACE OUTPUT FOR ANY APPLICATION



Plenty of space for mounting on the tractor and the swivelling PTO shaft.



MU-Vario® for an optimised intake and housing form and steplessly adjustable shredding rates. The result is ideal mulch quality and shredding performance.



A large swivel range makes it possible to work both behind and alongside the tractor. Narrow access tracks and field edges can be mulched just as easily.



The patented mechanical collision protection device responds reliably and returns automatically to the work position.



Starinth® rear roller bearing.



Rotating warning signs with LED lighting equipment and lighting equipment support with sturdy mounting and without moving components (optional).

## Technical Specifications

MU-L/S Vario	200	220	250
Working width (cm)	200	220	250
Max. tractor hp	130	130	130
Weight (kg)	910	930	950
Number of M-DuraX hammer flails	16	18	22
Minimum tractor weight (kg)	2.800	3.200	3.500

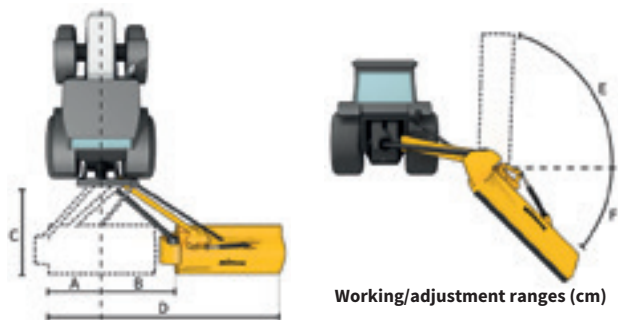

### Working/adjustment ranges (cm)

	200	220	250
A	70	70	70
B	105	105	105
C	200	200	200
D	375	395	425
E	90	90	90
F	60	60	60

- A Adjustment range to left approx.
- B Adjustment range to right approx.
- C Transport length to rear approx.
- D Total working range incl. equipment width approx.

### Working ranges (°)

- E Angular range upwards
- F Angular range downwards

# MU-M Vario

## A HIGH STANDARD FOR ALL FARMERS

- Universally suited to any application area
- MU-Vario® system as standard
- Front and rear mounting as standard
- Hydraulic side shift as standard
- Crop discharge in front of the large support roller is also possible as standard. For example: For good germination of volunteer rape plants and when operating under difficult conditions
- Long service life thanks to the internal Starinth® rear roller bearing system
- Fast maintenance thanks to easily accessible and clearly marked lubrication points and automatic belt tensioning
- Extremely narrow and exchangeable wear runners ensure blockage-free operation and prevent crop accumulation

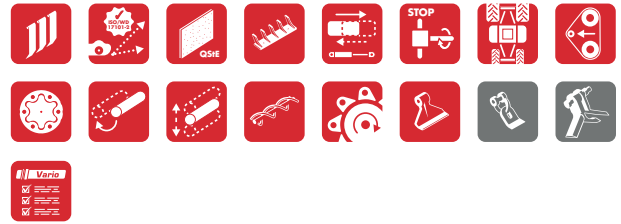

Driving power in hp:



Working width in metres:



# STRONG PERFORMANCE WITH THE VERSATILE MID-RANGE FLAIL MOWER



Sturdy front/rear headstock with hydraulic side shift (56 cm adjustment range).



MU-Vario® for an optimised intake and housing form and steplessly adjustable shredding rates. The result is ideal mulch quality and shredding performance.



Trouble-free and low-maintenance operation due to the efficient design of the automatic belt tensing system.



Starinth® rear roller bearing.



The scraper keeps the support roller clean and reduces dust development (optional).



For a long service life: the exchangeable wear insert and carbide wear runners.



Easy adjustment of the swivelling support roller, even without an assistant.



Elongated holes in Cat. 2 on the upper and lower link mounting points ensure excellent ground adaptation in combination with the swivelling support roller.



The front shock-absorbing spring assembly provides optimised ground adaptation and leads to better traction and steering characteristics of the tractor by loading the front axle (optional).

## Technical Specifications

MU-M Vario	220	250	280	300
Working width (cm)	220	250	280	300
Total width (cm)	240	270	300	320
Max. tractor hp 1000 rpm	160	160	160	160
Weight (kg)	905	975	1.010	1.085
Number of M-DuraX hammer flails	18	22	24	26

# MU-Vario-Shark 2.0

## THE FARMING SPECIALIST

- Arable farming special edition in special colour for front and rear mounting with additional equipment
- Suitable for all areas of arable farming
- Headstock designed for large tractor series
- Hydraulic side shift with nylon mounted adjustable tubes
- Infinitely variable shredding rate thanks to the MU-Vario® system installed as standard
- Adjustable cutting bar for rapid adjustment to any type of crop or conditions
- Scraper optionally available
- Optimised clearance between support roller and rotor to ensure that even long stalks are processed in their entirety

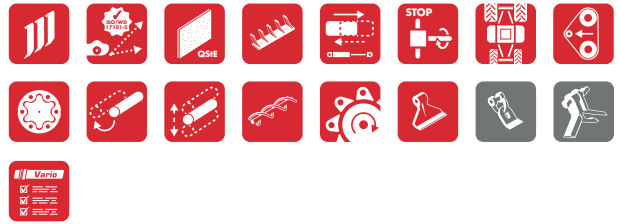

Driving power in hp:



Working width in metres:



- Screw-type short chopping bar system: "Shark fin" design - a Müthing patent
- MU-SOFA® weight transfer system (optional)



# SPECIAL EDITION FOR FRONT AND REAR MOUNTING UP TO 200 HP



Easy adjustment of the swivelling support roller even without additional help.

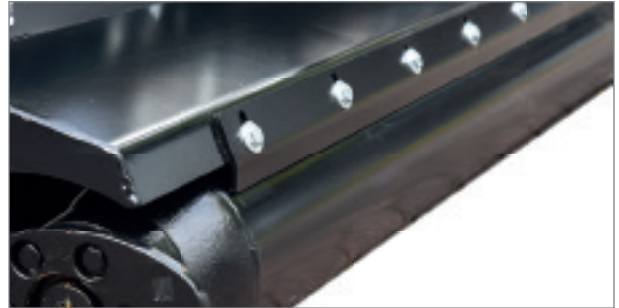

The scraper keeps the support roller clean and reduces dust development (optional).

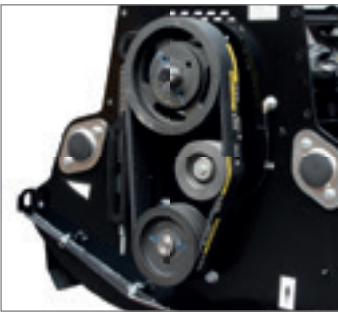

Trouble-free and low-maintenance operation due to the efficient design of the automatic belt tensioning system.

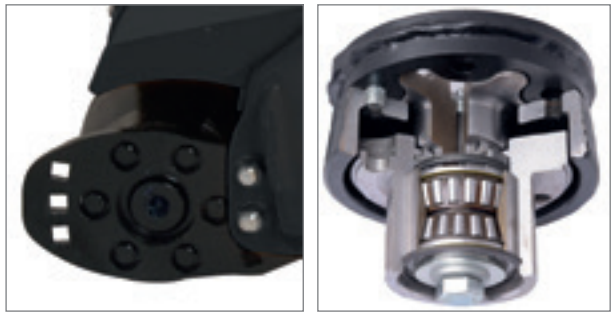

Starinth® support roller bearing

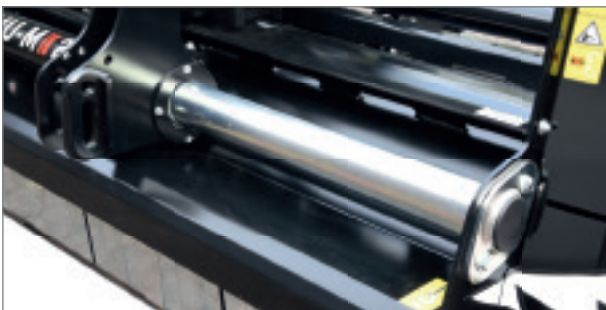

The hydraulic side shift system is equipped with adjustable tubes with plastic mounts for low-wear continuous use.

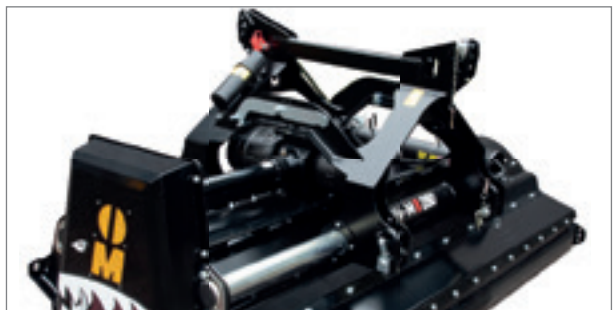

Sturdy front/rear attachment with hydraulic side shift (56 cm adjustment travel).

## Technical Specifications

MU-Vario-Shark 2.0	280	300
Working width (cm)	280	300
Max. tractor hp	200	200
Weight (kg)	1.112	1.193
Number of M-DuraX hammer flails	24	26

# MU-M/F Vario

## HIGH OUTPUT, FAST FIELD CHANGES AND SIMPLE HANDLING

- Easy turning and manoeuvring thanks to support wheels that rotate 360°
- MU-Vario® system as standard
- Folds hydraulically for fast field changes without getting off the tractor
- The hydraulically driven central strip flail mower allows you to mulch every last blade
- The cutting height can be steplessly adjusted without the use of tools
- Folds up for space-saving storage
- New 2Cut rotor generations (optional)
- Support roller possible instead of support wheels (optional)



Driving power in hp:



Working width in metres:



# STRONG PERFORMANCE AND FLEXIBILITY



Fast change from transport to working position. Manageable transport position with 2.85 m transport width and 3.60 m transport height.



MU-Vario® for an optimised intake and housing form and steplessly adjustable shredding rates. The result is ideal mulch quality and shredding performance.



Maximum manoeuvrability at the headland.



The turnbuckle allows you to quickly set the correct cutting height.



Hydraulically driven strip flail mower - Required hydraulic connections: 1 x pressure line with BG 2 plug, 1 x pressureless return line with BG 3 socket, (optional)



A clever design allows the MU-M/F flail mower to be folded up for space-saving storage.



Trouble free and low maintenance operation due to the efficient design of the automatic belt tensioning system.

## Technical Specifications

MU-M/F 600 Vario	600
Working width (cm)	600
Total width (cm)	634
Max. tractor hp	300
Weight (kg)	2.700

Number of M-DuraX Series hammer flails/2Cut 52/96



Large swivelling support rollers for the option of discharging the crop either behind or in front of the roller and for working height adjustment (optional).

# MU-M/S

## ACHIEVE PROFESSIONAL WORK RESULTS – REGARDLESS OF THE APPLICATION

- Consistent mulching result on the flat due to flail mower housing suspension system
- Side shift as standard provides stability for the tractor and makes even deep ditches accessible (optional)
- Whether you are working in ditches or on embankments, the MU-M/S automatically follows every contour
- Hydraulic non stop collision protection device
- Long service life thanks to the internal Starinth® support roller bearing



Driving power in hp:



Working width in metres:





# STRONG ON THE FLAT VERSATILE ON EMBANKMENTS AND IN DITCHES



Short design for a centre of gravity close to the tractor.



Sturdy 3-point linkage with Cat. 2 and 3 mounting points.

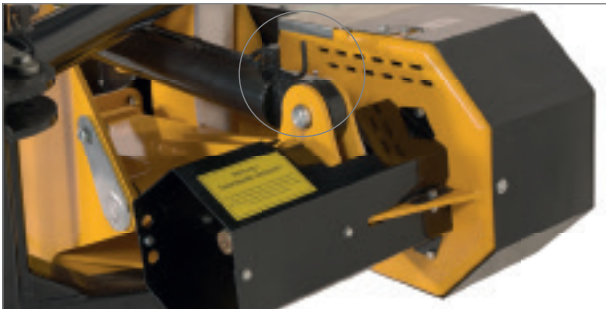

Easily accessible transport safety device.



In the event of a problem, the hydraulic non-stop collision protection device swivels the flail mower out of the collision zone effectively.

## Technical Specifications

MU-M/S	180	200	220	250
Working width (cm)	180	200	220	250
Max. tractor hp 1000 rpm	160	160	160	160
Weight (kg)	1.140	1.210	1.280	1.380
M-DuraX hammer flails	16	16	18	22

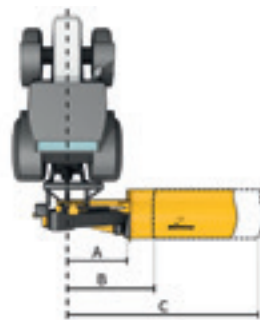

### Working/adjustment ranges (cm)

	180	200	220	250
<b>A</b>	120	120	120	120
<b>B</b>	165	165	165	165
<b>C</b>	345	365	385	415
<b>E</b>	90	90	90	90
<b>F</b>	60	60	60	60

**A** Side mounting to right approx.  
**B** Adjustment range to right approx.  
**C** Total width to right approx.

### Working ranges (°)

**E** Angular range upwards  
**F** Angular range downwards

# MU-M/S VARIO PLUS

## FOR EXTRA FLEXIBILITY AND WORKING WIDTH

- Unrivalled adjustment range of 101 cm: Inner edge of flail mower from 73 cm to 174 cm (outwards from tractor centre)
- Combined usage with up to 5.5 m working width
- Slewing range from -60° to 90°
- Plateau function for working alongside the tractor at different levels (max. 1.10 m height difference)
- Single lever operation on flat surface
- Long service life thanks to the internal Starinth® support roller bearing



Driving power in hp:



Working width in metres:



**NEW**



# COMBINES MAXIMUM WORKING CONVENIENCE WITH MAXIMUM SURFACE OUTPUT



Innovative hydraulic collision protection device for forward and reverse travel.



Hydropneumatic weight transfer system for optimal ground adaptation.



A clever design allows the flail mower to be folded up for space-saving storage.



Electric remote control for switching between use on the flat and ditch maintenance.

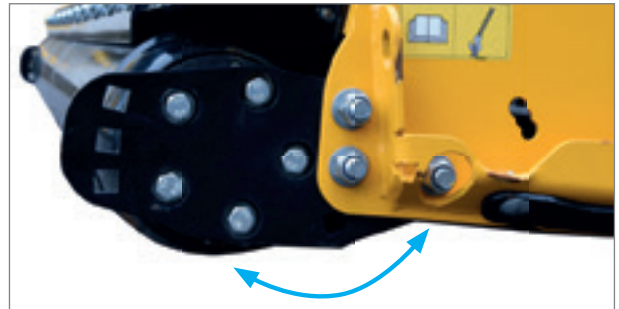

Swivelling support roller.

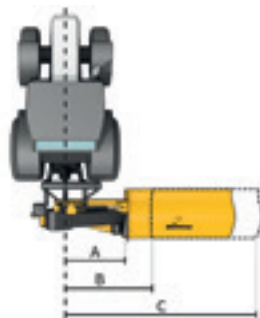

	220	250	280
A	73	73	73
B	174	174	174
C	400	430	460
E	90	90	90
F	60	60	60

#### Working/adjustment ranges (cm)

- A Side mounting to right approx.
- B Adjustment range to right approx.
- C Total width to right approx.

#### Working ranges (°)

- E Angular range upwards
- F Angular range downwards

## Technical Specifications

MU-M/S Vario PLUS	220	250	280
Working width (cm)	220	250	280
Max. tractor hp 1000 rpm	200	200	200
Weight (kg)	1.700	1.800	1.900
M-DuraX/2Cut hammer flails	18	22	24

Dimensional specifications are approximate and may vary between tractors.

# MU-PRO Vario

## MAXIMUM THROUGHPUT, SHREDDING, PERFORMANCE

- Leaves no desire unfulfilled - The generous standard equipment
- MU-Vario® system as standard
- Front and rear mounting as standard
- High quantities of biomass thanks to large MU-Vario® housing opening
- Crop discharge in front of the large support roller is also possible as standard. For example: For good germination of volunteer rape plants and when operating under difficult conditions
- Fast maintenance thanks to easily accessible and clearly marked lubrication points and automatic belt tensioning
- New 2Cut rotor generation (optional)



Driving power in hp:



Working width in metres:



- Long service life thanks to the internal Starinth® support roller bearing
- Extremely narrow and exchangeable wear runners ensure blockage free operation and prevent crop accumulation



# PRO, FOR THE PROFESSIONAL USER



Sturdy front/rear headstock with hydraulic side shift (56 cm adjustment range) and Cat. 2+3 mounting points.



MU-Vario® for an optimised intake and housing form and steplessly adjustable shredding rates. The result is ideal mulch quality and shredding performance.



Trouble-free and low-maintenance operation due to the efficient design of the automatic belt tensioning system.



The integrated material guiding flap ensures blockage-free discharge.



Easy adjustment of the swivelling support roller, even without an assistant.



The scraper keeps the large support roller clean and reduces dust development (optional).



Starinth® rear roller bearing.



Elongated holes on the upper and lower link mounting points ensure excellent ground following in combination with the swivelling support roller.



The Vario-Shift adjustable hydraulic cutting bar enables fast, infinitely variable adjustment of the shredding rate to the respective requirements directly from the driver's cab (optionally available for MU-PRO Vario 280).

## Technical Specifications

	MU-PRO Vario	250	280	300	320
Working width (cm)		250	280	300	320
Total width (cm)		270	300	320	340
Max. tractor hp		220	220	220	220
Weight (kg)		1.330	1.400	1.460	1.500
Number of M-DuraX Series hammer flails/2Cut		22/38	24/42	26/46	28/48

# MU-COVERSEEDER

## THE ALL-ROUNDER IN CROP PRODUCTION

Its innovative machine concept enables the sowing of catch crops and vegetation and the processing of crop residues in one pass.

- Highly tempered M-DuraX hammer flails, forged from special steel
- Smooth running rotor with specially formed tool holders arranged in a spiral pattern
- Hardox wear runners with separating effect, screw type
- MU-Vario® system as standard
- Wear insert in housing (fitted)
- Warning signs with LED lighting equipment with turn signal failure indicator for rear attachment incl. 4 m cable
- PTO shaft with hardened inner tube and cap bottom lubrication – heavy-duty version
- Self cleaning prism roller to create a fine tilth soil structure and seed to soil contact for the seed grain – can also be used separately

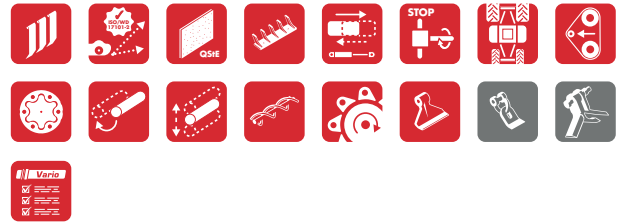

Driving power in hp:



Working width in metres:



**NEW**



You can see the COVERSEEDER in action here.

**Just scan the QR code to get started.**



# SUSTAINABILITY FROM HARVEST TO SOWING



The integrated harrow with 16 harrow tines is used to raise pressed stubble before the mulching pass and produce fine soil.



The prism roller with a diameter of 38 cm and the proven "dimpled compaction effect", in combination with the fine soil, ensures perfect seed to soil contact.



The roller and the harrow can also be used separately thanks to simple and quick (dis)assembly. Solo use - No problem!



Pneumatic sowing device for CoverSeeder comprising pneumatic seeder (incl. operator terminal) and coulter bar in flail mower housing for broadcast seeding on the soil surface.



Seed application with broadcast seeding method.

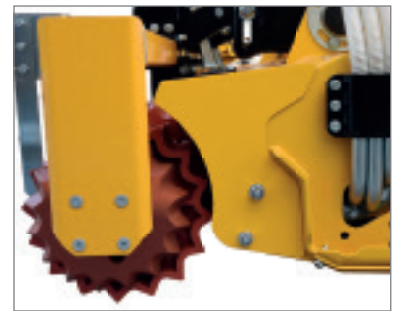

Dust protection - Extension at flail mower housing reduces dust generation and soiling.



Trouble-free and low-maintenance operation due to the efficient design of the automatic belt tensoning system.



Easy filling of seed tank thanks to a folding step.

## Technical Specifications

MU-CoverSeeder	280
Working width (cm)	280
Max. tractor hp 1000 rpm	250
Weight (kg)	2.550
M-DuraX/2Cut hammer flails	24/42



INNOVATION  
AWARD

Agritechnica

# MU-PRO/F Vario

## MAXIMUM SURFACE OUTPUT

- The clever offset design allows driving powers of up to 400 hp
- User friendly handling with just one operation needed at the headland
- MU-Vario® system as standard
- Well balanced: Combination with a MU-PRO Vario front flail mower produces an optimal weight distribution
- Maximum working width of 8.60 m in the field, manageable transport position with 2.85 m transport width and overall height well below 4 m
- Built out of high strength fine-grain steel S700MC for a low dead weight combined with extreme strength
- Long service life thanks to the internal Starinth® support roller bearing
- Perfect ground following due to the MU-SOFA® weight transfer system
- New 2Cut rotor generation (optional)



Driving power in hp:



Working width in metres:



- Folds up for transport and space saving storage
- Maintenance friendly, thanks to easily accessible and clearly marked lubrication points, as well as automatic belt tensioning



OUR VIDEO TIP

The Muthing MU-PRO/F Vario flail mower in use on grain, rape and maize stubble can be viewed on YouTube. Just scan the QR code!

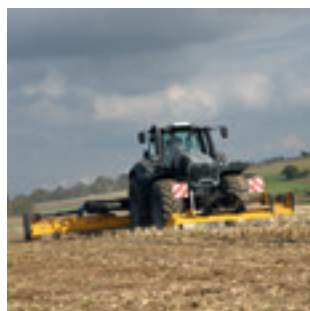



# THE PRO WITH MAXIMUM PERFORMANCE RANGE



Short design for a centre of gravity close to the tractor (quick hitch-suitable).

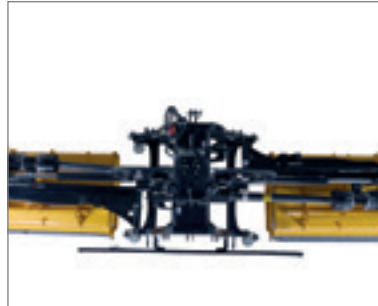

The clever offset design allows for a high-performance twin gear box and split power transmission to each side.

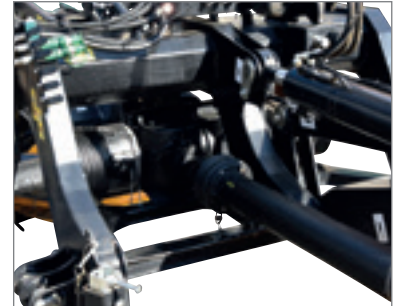

The gear box: Designed for driving powers of up to 400 HP.



A clever design allows the MU-PRO/F Vario flail mower to be folded up for space-saving storage.



Clever folding: Minimal equipment height due to the parallelogram-type suspension of the two flail mower housings.

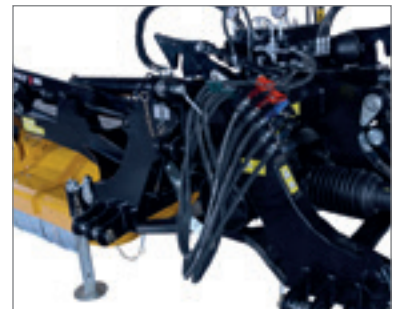

Tidy: The on-board hydraulics with the hydro-pneumatic MU-SOFA® weight transfer system.



Trouble-free and low-maintenance operation due to the efficient design of the automatic belt tensioning system.



The flail mower wings can also be lifted individually (optional).

## Technical Specifications

MU-PRO/F 860 Vario	860	280
Working width (cm)	860	280
Outer side (cm)	900	300
Max. tractor hp 1000 rpm	400	250
Weight (kg)	3.600	1.400
Number of M-DuraX Series hammer flails/ 2Cut	56/96	24/42

# MU-PRO/F Trail Vario

## DRAWN LARGE-AREA FLAIL MOWER FOR ALMOST ANY TRACTOR VEHICLE UP TO 500 HP

- Ideal for tractors without front PTO shaft for maximum surface output
- Optimal shredding of crop residues thanks to the MU-Vario® system installed as standard
- Chassis with excellent ride comfort and hydraulically adjustable work and transport position
- Folds in and out quickly to achieve a transport width of less than 3 m
- Large swivelling support roller for the option of discharging the mulch either behind or in front of the roller for optimal germination conditions
- Screw type short chopping bar system: "Shark fin" design – a Mühling patent



### OUR VIDEO TIP

The Mühling MU-PRO/F Trail flail mower in use on grain, rape and maize stubble can be viewed on YouTube. Just scan the QR code!



Driving power in hp:

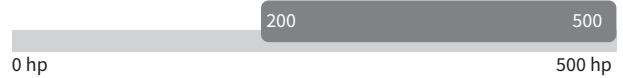

Working width in metres:



- MU-SOFA® weight transfer system (optional)
- Hardox wear runners, screw-type
- Starinth® support roller bearing



# IDEAL FOR MAXIMUM SURFACE OUTPUT



Ideal for tractors without front PTO shaft.



The clever design allows for a high-performance twin gear box and split power transmission to each side.



The optimal work position can be conveniently selected using the clearly visible indicator.



Tidy: The on-board hydraulics with the hydro-pneumatic MU-SOFA® weight transfer system.



The hydraulically adjustable working and transport position ensures a transport height of less than 4 m.



Folds in and out quickly to achieve a transport width of less than 3 m.



Trouble-free and low-maintenance operation due to the efficient design of the automatic belt tensioning system.

## Technical Specifications

<b>MU-PRO/F Trail Vario</b>	<b>860</b>
Working width (cm)	860
Outer side (cm)	900
Max. tractor hp 1000 rpm	500
Weight (kg)	6.500
Number of M-DuraX Series hammer flails/2Cut	56/96

# MU-PRO/S Vario

## MAXIMUM FLEXIBILITY, FULL POWER IN EVERY WORK POSITION

- Optimal power flow due to swing drive system
- MU-Vario® system as standard
- Guaranteed durability: Solid mounting frame, hydraulic collision protection device and wear insert as standard
- Agile handling despite solid design
- The ideal working width extender on the flat in combination with a front-mounted implement
- Dense shrubbery in ditches, at field edges and hedges present no obstacle
- Long service life thanks to the internal Starinth® support roller bearing
- Fast maintenance thanks to easily accessible and clearly marked lubrication points and automatic belt tensioning
- Mulch both behind and alongside the tractor
- New 2Cut rotor generation (optional)



Driving power in hp:



Working width in metres:



# THE PROFESSIONAL SIDE-ARM SYSTEM

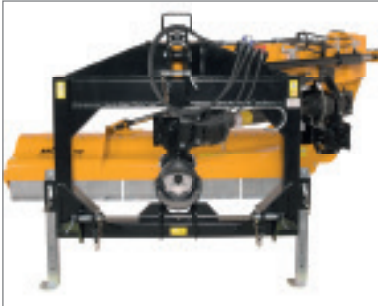

Torsionally stiff Cat. 3 headstock, highly resistant to stress even at maximum extension.

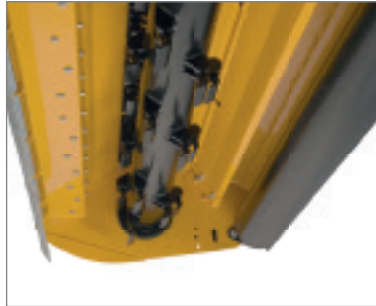

Easy adjustment of the swivelling support roller, even without an assistant. The integrated material guiding flap ensures blockage-free discharge.



Part-turn gearboxes in the moving links allow for maximum travel under constant power.



In the event of a problem, the hydraulic non-stop collision protection device swivels the flail mower out of the collision zone effectively.



Tidy: The hose routing.



Warning signs with lighting equipment and lighting beam with sturdy mounting wand without moving parts



MU-Vario® for an optimised intake and housing form and steplessly adjustable shredding rates. The result is ideal mulch quality and shredding performance.

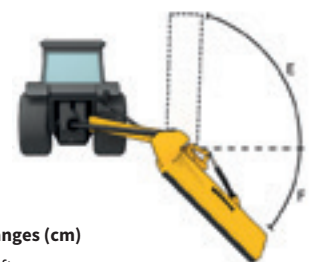
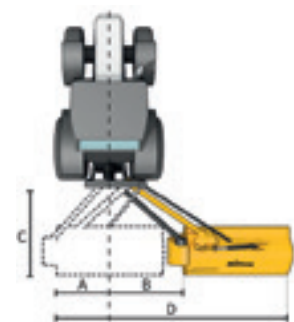

## Technical Specifications

	MU-PRO/S Vario	250
Working width (cm)		250
Max. tractor hp		220
Weight (kg)		1.900
Number of M-DuraX Series hammer flails/2Cut		22/38
Minimum tractor weight (kg)		7.000

Working/adjustment ranges (cm)	
<b>250</b>	<b>A</b> Adjustment range to left approx.
<b>A</b> 103	<b>B</b> Adjustment range to right approx.
<b>B</b> 193	<b>C</b> Transport length to rear approx.
<b>C</b> 370	<b>D</b> Total working range incl. equipment width approx.
<b>D</b> 546	<b>Working ranges (°)</b>
<b>E</b> 90	<b>E</b> Angular range upwards
<b>F</b> 60	<b>F</b> Angular range downwards

# MU-Farmer® 670

## WIDE, FAST, STRONG – MU-FARMER® 670

- Large amounts of biomass and high ground speeds - the MU-Farmer® can do both
- Blockage free discharge even of large quantities of shredded biomass thanks to the trailing support wheels
- Special MU-Farmer® hammer flails with 3 year warranty against breakage. This rolled steel tool offers extremely high durability
- A large clearance from the working level to the sizeable rotor ensures operational safety
- Ground protection and operational safety with the large trailing support wheels
- Stay in close contact with the ground: working close to the ground is possible even under difficult conditions



Driving power in hp:



Working width in metres:



- The full length housing provides maximum stability
- Doing some shredding? MU-Farmer®: With the highest cutting speed on the market
- Change fields quickly and safely with the lengthways transport system (optional)
- The MU-Farmer® – The best at building up humus levels



OUR VIDEO TIP

**Müthing MU-Farmer® 670 flail mower** in use on fallow land, maize stubble and maize stover can be viewed on YouTube. Just scan the QR code!



# HARD WORK IS ITS DAILY BREAD



Twice the safety with two rows high tempered one way spring steel protections flaps.



Power in reserve: The solid, generously dimensioned rotor.



Indestructible: Made out of rolled steel and weighing 2.7 kg, the MU-Farmer® hammer flails ensure a long service life even under high throughput of plant mass or with light ground contact.



Trouble-free and low-maintenance operation due to the efficient design of the automatic belt tensing system.



Powerful drive on both sides for up to 300 hp of driving power. Durability even under the toughest conditions thanks to the sturdy frame structure of the housing.



Quickly ready for operation: Uncouple the machine and bring the lengthways transport device into the work position / couple the MU-Farmer® 670 to the tractor with the quick coupling bar and connect the PTO shaft.

## Technical Specifications

MU-Farmer® 670	670
Working width (cm)	670
Total width (cm)	712
Transport length (cm)	972
Max. tractor hp 1000 rpm	300
Weight (kg)	4.460
Number of MU-Farmer® M-DuraX hammer flails	44



4 Low impact support wheels for vertical adjustment of the MU-Farmer® unit for rear attachment. 180° swiveling for high maneuverability at the headland.

# SERVICE

## RELIABILITY AS STANDARD

### The foundation of durability

Even in the early design phase of a M $\ddot{u}$ thing flail mower, reliability is one of the most important development criteria for us.

Irrespective of whether the equipment is being used to manage seasonal peaks, for tough day-to-day tasks or for intensive and continuous operation. We want you to be able to depend on your M $\ddot{u}$ thing flail mower - right from the beginning.

The M-DuraX mulching tool impresses with optimal ergonomic features combined with high strength boron alloyed and tempered steel for a perfect mulching result and up to 50% longer service life.

### Fast assistance

This means helping you without complication and within the shortest period of time - exactly when you really need it. To ensure that your M $\ddot{u}$ thing flail mower is back up and running again quickly.

### Genuine spare parts

M $\ddot{u}$ thing spare parts are designed to uphold our quality promise. Our selection of outstanding components ensures a long service life.

High quality spare parts are available for every flail mower. And they will be for a very long time after you have decided to purchase a M $\ddot{u}$ thing flail mower.

You can count on us. With M $\ddot{u}$ thing spare parts, we will quickly provide a long-lasting solution to your emergency.





# WHEN THE WORK CANNOT WAIT



## CORE EXPERTISE: SMOOTH-RUNNING ROTORS

The centrepiece of every flail mower is the rotor with its tools. The smooth running characteristics of a rotor have a strong influence on its service life, uniformity of work results and continuous power demand. Every Müthing rotor is designed to maintain these characteristics for a long time, even under heavy duty usage.

But if the worst comes to the worst and your rotor is damaged by foreign bodies, an imbalance can occur. With our in house balancing machine, our service team can help you quickly and without complication.

### Our service for you:



In-house balancing machine



Experienced experts



Genuine Müthing tools sorted into 3 weight stages (20 grams each)

# TECHNICAL DATA

	ECOTOP	MU-H Vario	MU-H/S Vario	MU-L Vario	MU-L/S Vario	MU-M Vario	MU-Vario-Shark 2.0	MU-M/F Vario
<b>Dimensions and weights</b>								
Working width (cm)	160 180 200	120 140 150 160 180 200 220	140 160 180 200	180 200 220 250 280	200 220 250	220 250 280 300	280 300	600
Transport width (cm)	177 197 217	137 157 167 177 197 217 237	n/a	197 217 237 267 297	n/a	240 270 300 320	300 320	285
Weight (kg)	352 372 390	380 465 480 500 535 555 635	650 660 690 720	640 670 740 790 885	910 930 950	905 975 1010 1085	1112 1193	2.700
<b>Driving power</b>								
Power demand* (hp)	30-60/75	35-75/90	55 - 90	45 - 100/130	75 - 130	75 - 160	95 - 200	130 - 300
Max. driving power (hp)	75	90	90	130	130	160	200	300
PTO shaft speed* (rpm)	540/1.000	540/1.000	540	540/1.000	540	1.000	1.000	1.000
Freewheel	■	■	■	■	■	■	■	■
Number of V-belts	3	3	4	4	4	4	4	10
<b>Mounting</b>								
Front	-	□	-	□	-	-	-	-
Rear	Cat. 1+2	□	Cat. 2	■	Cat. 2	-	-	Cat. 3
Front-Rear	-	Cat. 1+2	-	Cat. 1+2	-	Cat. 2	Cat. 2	-
Mechanical side shift (cm)	-	■	-	■	-	-	-	-
Hydraulic side shift (cm)	-	□	■	□	■	■	■	-
Swivel range (°)	-	-	-60° - +90°	-	-60° - +90°	-	-	-
Control devices	-	min. 1 DA	min. 2 DA	min. 1 DA	min. 2 DA	min. 1 DA	min. 1 DA	min. 2 SA
<b>Working/adjustment ranges</b>								
A: Adjustment range to left / A: Side mounting to right	-	n/a	55 55 55 55	n/a	70 70 70	n/a	n/a	-
B: Adjustment range to right	-	n/a	100 100 100 100	n/a	105 105 105	n/a	n/a	-
C: Transport length to rear / C: Total width to right	-	n/a	185 185 185 185	n/a	200 200 200	n/a	n/a	-
D: Total working range incl. equipment width	-	n/a	295 315 335 355	n/a	375 395 425	n/a	n/a	-
E: Angular range upwards	-	-	90°	-	90°	-	-	-
F: Angular range downwards	-	-	60°	-	60°	-	-	-
<b>Rotor</b>								
Diameter (cm)	14	14 14 14 14 14 14 16	14	16 16 16 16 18	16	17 17 17 19	17 19	20
Effective diameter (cm)	40	40 40 40 40 40 42	40	42 42 42 42 44	42	44 44 44 45	44 45	47
Farmer® hammer flail	-	-	-	-	-	-	-	-
M-DuraX hammer flails	■	■	■	■	■	■	■	■
<b>Depth control</b>								
Support roller	■	■	■	■	■	■	■	■
Front/rear position	Fixed	Fixed	Fixed	Fixed	Fixed	Swivelling	Swivelling	Swivelling
Diameter (cm)	14	14	14	19	19	19	19	19
Support wheels	-	-	-	-	-	-	-	□
<b>Housing</b>								
Wear insert	-	□	□	□	□	□	■	■
Hardox wear runners	-	■	■	■	■	■	■	■
Vario cutting bar	-	■	■	■	■	■	■	■
Short chopping bar (shark fin)	■	■	■	■	■	■	■	■
Second short chopping bar	-	□	□	□	□	□	□	□
<b>Optional equipment</b>								
Front shock-absorbing spring assembly	-	□	-	□	-	□	□	-
MU-SOFA® weight transfer system	-	□	-	□	-	□	□	-
Warning signs with LED lighting equipment	-	□	□	□	□	□	□	■
Operating hours counter	-	□	□	□	□	□	□	□

	MU-M/S	MU-M/S Vario PLUS	MU-PRO Vario	MU-CoverSeeder	MU-PRO/F Vario	MU-PRO/F Trail Vario	MU-PRO/S Vario	MU-Farmer® 670
<b>Dimensions and weights</b>								
Working width (cm)	180 200  220 250	220 250 280	250 280  300 320	280	860	860	250	670
Transport width (cm)	345 365  385 415	250	270 300  320 340	300	285	285	160	238
Weight (kg)	1140 1210  1280 1380	1700 1800 1900	1330 1400  1460 1500	2350	3.600	6.500	1.900	4.460
<b>Driving power</b>								
Power demand* (hp)	95 - 160	160 - 200	95 - 250	130 - 250	200 - 400	200 - 500	180 - 220	240 - 300
Max. driving power (hp)	160	200	250	250	400	500	220	300
PTO shaft speed* (rpm)	1.000	1.000	1.000	1.000	1.000	1.000	1.000	1.000
Freewheel	■	■	■	■	■	■	■	■
Number of V-belts	4 / 5	5/5	5	5	10	10	5	10
<b>Mounting</b>								
Front	-	-	-	-	-	-	-	-
Rear	Cat. 2+3	Cat. 2+3	-	Cat. 3	Cat. 3+4	K 80	Cat. 3	Cat. 3
Front-Rear	-	-	Cat. 2+3	Cat. 2+3	-	-	-	-
Mechanical side shift (cm)	-	-	-	-	-	-	-	-
Hydraulic side shift (cm)	■	■	■	-	-	-	■	-
Swivel range (°)	-60° - +90°	-60° - +90°	-	-	-	-	-60° - +90°	-
Control devices	min. 2 DA	1 DA + 2 SA	min. 1 DA	min. 1 DA	min. 2 DA	3 DA + 1 SA	min. 2 DA	min. 1 DA
<b>Working/adjustment ranges</b>								
A: Adjustment range to left / A: Side mounting to right	120 120 120 120	73	n/a	n/a	-	-	103	-
B: Adjustment range to right	165 165 165 165	174	n/a	n/a	-	-	193	-
C: Transport length to rear / C: Total width to right	345 365 385 415	n/a	n/a	n/a	-	-	370	-
D: Total working range incl. equipment width	n/a	400 430 460	n/a	n/a	-	-	546	-
E: Angular range upwards	90°	90°	-	-	-	-	90°	-
F: Angular range downwards	60°	60°	-	-	-	-	60°	-
<b>Rotor</b>								
Diameter (cm)	16	17	20	20	20	20	20	27
Effective diameter (cm)	42	44	47	47	47	47	47	69
Farmer® hammer flail	-	-	-	-	-	-	-	■
M-DuraX hammer flails	■	■	■	■	■	■	■	-
<b>Depth control</b>								
Support roller	■	■	■	□	■	■	■	-
Front/rear position	Adjustable	Adjustable	Swivelling	Swivelling	Swivelling	Swivelling	Swivelling	-
Diameter (cm)	24	24	24	24	24	24	24	-
Support wheels	-	-	-	-	□	-	-	■
<b>Housing</b>								
Wear insert	■	■	■	■	■	■	■	■
Hardox wear runners	■	■	■	■	■	■	■	■
Vario cutting bar	-	■	■	■	■	■	■	-
Short chopping bar (shark fin)	■	■	■	■	■	■	■	■
Second short chopping bar	□	□	□	-	□	□	□	■
<b>Optional equipment</b>								
Front shock-absorbing spring assembly	-	-	□	-	-	-	-	-
MU-SOFA® weight transfer system	-	■	□	-	■	■	-	-
Warning signs with LED lighting equipment	□	■	□	■	■	■	□	■
Operating hours counter	□	□	□	□	■	■	□	□

# OPTIMAL MULCHING WITH MÜTHING



## **Müthing**

**Müthing GmbH & Co. KG Soest**

Am Silberg 23  
D-59494 Soest

Tel. + 49 (0) 2921 96510

Fax + 49 (0) 2921 73080

[soest@muething.com](mailto:soest@muething.com)

**Müthing GmbH & Co. KG Uffenheim**

Am Brunnlein 2  
D-97215 Uffenheim

Tel. + 49 (0) 9842 98660

Fax + 49 (0) 9842 98667

[uffenheim@muething.com](mailto:uffenheim@muething.com)

[www.muething.com](http://www.muething.com)



## Your Contact:

**SIMON RICHARD LTD**

Crown Tailrig • Bonchester Bridge • Hawick • TD9 8RA

Tel: 01450 860774 • Fax: 01450 860772

E-mail: [simon@simon-richard.co.uk](mailto:simon@simon-richard.co.uk)

[www.simon-richard.co.uk](http://www.simon-richard.co.uk)